



**JONESCO**

[www.jonesco-plastics.com](http://www.jonesco-plastics.com)



**Fire & Safety Products**

**Produits Incendie et Sécurité**

**Brandschutz- & Sicherheitsprodukte**

**v14**



**ISO 9001:2000**



**JONESCO**



**Strong design and lightweight • Resistant to most chemicals • Made from environmentally friendly PE-fully recyclable • Higher impact strength than equivalent GRP boxes • UV resistant •**

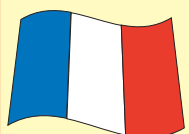

**Structure renforcée et légère • Résistant aux produits chimiques • Fabriqué dans un polyéthylène recyclable-respectueux de l'environnement • Résistance aux impacts supérieure aux coffres en polyester • Résistante aux U.V. •**



**leicht und robust • chemikalienbeständig • aus umweltfreundlichem PE-100%ig recycelbar • höhere Schlagfestigkeit als vergleichbare Kästen aus GFK • UV-beständig •**



Front Loaders / Chargement Frontal / Frontlader	3
Top Loaders / Chargement Par Les Dessus / Toplader	12
Storage Boxes / Coffres Des Rangement Multi Usages / Staukästen	15
Fire Stands / Socle Porte Extincteur / Feuerlöscherständer	16
Accessories / Accessoires / Zubehör	20
Fitting Variations / Possibilité de Montage / Anbauvarianten	22



**JFEX01**

For wall mounting only • Not for use on commercial vehicles  
 For in-door/out-door storage of Fire extinguishers •  
 Strengthened base to accommodate extinguisher, no  
 additional fixings required • Detachable lid for immediate  
 access in case of emergency • Rubber fastening toggles •  
 Textured surface finish • Economical • UV-stabilized to retain  
 colour fastness • Fire extinguisher label.

Peut équiper atelier seulement • Ne se monte pas sur  
 véhicules industriels • Pour le stockage extérieur ou intérieur  
 de l'extincteur • Grâce à sa base renforcée, il n'est pas  
 nécessaire d'utiliser de fixations supplémentaires • Couvercle  
 amovible pour accès immédiat en cas d'urgence • Attache-  
 capot caoutchouc • Etat de surface grainé • Economique •  
 Couleur stabilisée et résistante aux U.V. • Etiquette  
 <Extincteur> fournie.

nur für Wandmontage • nicht für LKW-Montage, etc. geeignet •  
 für die Aufbewahrung von Feuerlöschern in Gebäuden sowie  
 im Freien • verstärkte Löscher-Standfläche, keine Halter  
 erforderlich • durch abnehmbare Haube im Ernstfall sofort  
 griffbereit • Gummiverschlüsse • strukturierte Oberfläche •  
 ökonomisch • hervorragende UV-Beständigkeit •  
 Feuerlöscher-Piktogramm.

**JFEX02 • JFEX03**

Plastic box for extinguishers • Ideal for use in truck cabs,  
 houses, mobile homes etc • JFEX02 - Red back, transparent  
 front, Rubber toggles • JFEX03 - Detachable lid for immediate  
 access in case of emergency.





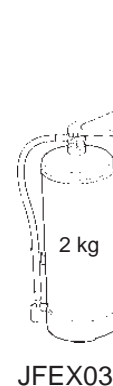
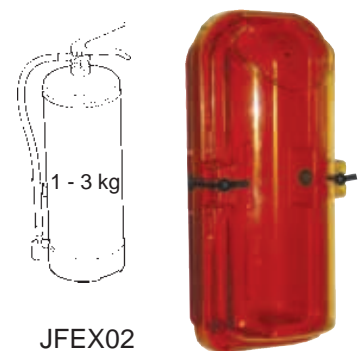

Coffre plastique pour extincteurs • Idéal pour usage  
 domestique, sur véhicules motorisés etc • JFEX02 - Dos  
 rouge, façade translucide, Grenouillères en caoutchouc •  
 JFEX03 - Couvercle amovible pour accès immédiat en cas  
 d'urgence.

Kunststoffkasten für Feuerlöscher • geeignet für Lkw-Kabine,  
 Gebäude, Wohnwagen, etc • JFEX02 - roter Kasten,  
 Klarsichtdeckel, Gummiverschlüsse • JFEX03 - durch  
 abnehmbare Haube im Ernstfall sofort griffbereit.



Type		
JFEX01		



Type	 mm	 mm	 mm	 mm	 mm	 mm
JFEX01	560	640	190	250	180	250
JFEX02	345	380	150	180	130	145
JFEX03	405	415	185	210	120	145

56 Series

Série "56"

56er-Reihe

mm	mm	mm	mm	mm	mm
500	610	395	500	140	190

Type			
HRE56			
HRR56			

Suitable for in-door/out-door storage of hose reel and nozzle • woven strap to secure contents • Water resistant seal • Can also be used as key cabinet, Emergency plan storage box or first aid kit box.

Pour le stockage à l'intérieur et à l'extérieur des bâtiments, des tuyaux d'incendie et tuyaux à bec • Sangle de maintien du contenu • Etanche - peut être utilisé comme armoire à clé, boîte de stockage de plan d'évacuation ou équipement de premier secours.

für die Aufbewahrung von Druckschläuchen und Mehrzweckstrahlrohren im Innern sowie im Freien • Inhalt-Sicherungsgurt • Wasserdichtung • auch einsetzbar als Schlüsselkasten, Notplan-Kasten oder Erste-Hilfe-Kasten.



HRE56



HRE56

68 Series

Série "68"

68er-Reihe

mm	mm	mm	mm	mm	mm
585	680	230	260	220	260

Type		
JBTB68		
JBTE68		



Truck or wall mounting • Neoprene seal • Detachable lid • Buckle Web Strap • Plastic toggle and Lynch pin as standard\* • FE label supplied loose.

Peut équiper véhicules et ateliers • Joint néoprène • Couvercle amovible • Sangle Renforcée • Goupille de sécurité\* et Grenouillère plastique avec chaque coffre • Etiquette <Extincteur>.

LKW-/Wandmontage • Neoprendichtung • abnehmbarer Deckel • Gurtband mit Schnalle • Verschlussbügel und Klappsplint\* aus Kunststoff • Feuerlöscher-Piktogramm lose beigelegt.

JBTB68

JBTE68



\*Lynch pin/Goupille de sécurité/Klappsplint

70 Series

Série "70"

70er-Reihe



mm	mm	mm	mm	mm	mm
625	700	260	320	195	255

Truck or wall mounting • Rubber seal and polycarbonate windows • Left or right hinged mounting • Buckle Web Strap • Plastic toggle, lynch pin and hinge pins as standard • FE label supplied loose • Optional extra: Factory fitted alarm, coding example: JBWE70A.

Peut équiper véhicules et ateliers • Joint caoutchouc et hublot en polycarbonate • Montage réversible avec ouverture de porte à droite ou à gauche • Sangle Renforcée • Goupille de sécurité, charnières et fermetures en plastique avec chaque coffre • Etiquette <Extincteur> • En Option: Alarme - Montage en usine, par exemple JBWE70A.

LKW-/Wandmontage • Gummidichtung + Sichtfenster aus Polycarbonat • Montage mit Scharnieren nach rechts bzw. links • Gurtband mit Schnalle • Verschlussbügel, Klappsplint und Scharniere aus Kunststoff • Feuerlöscher-Piktogramm lose beigefügt • Extras: Alarm (werkseitig montiert), Typenennung: z.B. JBWE70A.



JBWE70

Type			
JBWB70	●	●	✓
JBWE70	●	●	✓
JBWF70^	●	●	
JBWR70	●	●	✓
JBWS70^	●	●	
JBWY70^	●	●	
*JBXB70	●	●	✓
*JBXE70	●	●	✓
*JBXR70	●	●	✓

\*Internal Rubber Restraints  
 \*Sangle de maintien caoutchouc  
 \*Innenhaltebänder aus Gummi

83 Series

Série "83"

83er-Reihe

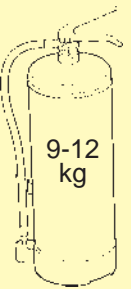

mm	mm	mm	mm	mm	mm
755	830	270	330	200	330

Truck or wall mounting • Rubber seal and polycarbonate windows • Left or right hinged mounting • Buckle Web Strap • Plastic toggle, lynch pin and hinge pins as standard • FE label supplied loose • Optional extras: Factory fitted alarm.

Peut équiper véhicules et ateliers • Joint caoutchouc et hublot en polycarbonate • Montage réversible avec ouverture de porte à droite ou à gauche • Sangle Renforcée • Goupille de sécurité, charnières et fermetures en plastique avec chaque coffre • Etiquette <Extincteur> • En option: Alarme - Montage en usine.

LKW-/Wandmontage • Gummidichtung + Sichtfenster aus Polycarbonat • Montage mit Scharnieren nach rechts bzw. links • Gurtband mit Schnalle • Verschlussbügel, Klappsplint und Scharniere aus Kunststoff • Feuerlöscher-Piktogramm lose beigefügt • Extras: Alarm (werkseitig montiert).

Type			
JBXB83	●	●	✓
JBXE83	●	●	✓
JBXF83^	●	●	
JBXR83	●	●	✓



JBXB83

^ Wall mounting only  
 ^ Peut équiper atelier seulement  
 ^ nur für Wandmontage

73 Series

Série "73"

73er-Reihe

						$\varnothing$ max mm	
625	730	350	435	225	290	200	610

Suitable for use with cartridge and horn extinguisher • For extinguishers up to 12 kg • Truck or wall mounting • Rubber seal and polycarbonate windows • Left or right hinged mounting • Buckle Web Strap • Plastic toggle, Lynch pin and hinge pins as standard • FE label supplied loose • Optional extras: Feet for use when free-standing (Kit 52), Factory fitted alarm.

Convient pour une utilisation avec cartouche et extincteur avec diffuseur • Coffre pour extincteur • Peut équiper véhicules et ateliers • Joint caoutchouc et hublot en polycarbonate • Montage réversible avec ouverture de porte à droite ou à gauche • Sangle Renforcée • Goupille de sécurité, charnières et fermetures en plastique avec chaque coffre • Etiquette <Extincteur> • En option: Pied support pour utilisation du coffre seul (Kit 52), Alarme - Montage en usine.

für Feuerlöscher mit Schneerohr bzw. außenliegender Druckgasflasche geeignet • für Feuerlöscher bis 12 kg Inhalt • LKW-/Wandmontage • Gummidichtung + Sichtfenster aus Polycarbonat • Montage mit Scharnieren nach rechts bzw. links • Gurtband mit Schnalle • Verschlussbügel und Klappsplint aus Kunststoff • Feuerlöscher-Piktogramm lose beigefügt • Extras: Füße, falls freistehend eingesetzt (Kit 52), Alarm (werkseitig montiert).



JBDE73

Type			
JBDE73	●	●	✓
JBDR73	●	●	✓

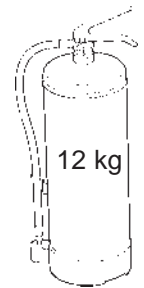

72 Series

Série "72"

72er-Reihe

650	720	530	585	210	270

For 2 extinguishers up to 12 kg • Truck or wall mounting • Rubber seal and polycarbonate windows • Left or right hinged mounting • Buckle Web Strap • Wooden base plate • Plastic toggle and Lynch pin as standard • FE label supplied loose • Optional extras: Feet for use when free-standing (Kit 52), Plastic Shelf (KIT SHELF72), Factory fitted alarm.

Coffre pour 2 extincteurs • Peut équiper véhicules et ateliers • Joint caoutchouc et hublot en polycarbonate • Montage réversible avec ouverture de porte à droite ou à gauche • Sangle Renforcée • Fond support en bois • Goupille de sécurité et Grenouillère plastique avec chaque coffre • Etiquette <Extincteur> • En option: Pied support pour utilisation du coffre seul (Kit 52), Etagères en plastique (KIT SHELF72), Alarme - Montage en usine.

für 2 Feuerlöscher bis 12 kg Inhalt • LKW-/Wandmontage • Gummidichtung + Sichtfenster aus Polycarbonat • Montage mit Scharnieren nach rechts bzw. links • Gurtband mit Schnalle • Holz-Einlegeboden • Verschlussbügel und Klappsplint aus Kunststoff • Feuerlöscher-Piktogramm lose beigefügt • Extras: Füße, falls freistehend eingesetzt (Kit 52), Kunststoffablegefächer (KIT SHELF72), Alarm (werkseitig montiert).



JBDB72



Type			
JBDB72	●	●	✓
JBDE72	●	●	✓
JBDR72	●	●	✓

**85 Series**

**Série "85"**

**85er-Reihe**

For the storage of Fire extinguishers, Breathing apparatus equipment. Firehose reels, First aid equipment and materials • 'T' handle door lock • Rubber seal and polycarbonate windows • Left or right hinged mounting • Wooden base plate • Fire extinguisher, fire hose reel, breathing apparatus and first aid labels • Optional Extra: Factory fitted alarm, 2 wooden shelves (Kit 57), 2 plastic shelves (KIT SHELF85).

Pour le stockage d'extincteurs, Appareil respiratoire, Tuyaux d'incendie, Trousse de 1<sup>er</sup> secours • Fermeture avec poignée T • Joint caoutchouc et hublot en polycarbonate • Montage réversible avec ouverture de porte à droite ou à gauche • Fond support en bois • Auto-Collant: Extincteur - tuyaux d'incendie - appareil respiratoire - 1<sup>er</sup> secours • En option: Alarme - Montage en usine, 2 étagères en bois (Kit 57), 2 étagères en plastique (KIT SHELF85).

für Feuerlöscher, Atemschutzgeräte, Druckschläuche, Erste-Hilfe-Ausrüstungen • Verschlußsystem mit T-Griff • Gummidichtung + Sichtfenster aus Polycarbonat • Montage mit Scharnieren nach rechts bzw. links • Holz-Einlegeboden • Feuerlöscher-, Löschschlauch-, Atemschutz- sowie Erste-Hilfe-Aufkleber • Extra: Alarm (werkseitig montiert), 2 Holzablegefächer (Kit 57), 2 Kunststoffablegefächer (KIT SHELF85).

**90 Series**



**Série "90"**

**90er-Reihe**

For in-door/out-door storage of Fire extinguishers, Hose reels, Breathing apparatus, Chemicals and spillage equipment • Wall mounted or free-standing • Rubber seal and polycarbonate windows • Left or right hinged mounting • Plastic locks and key compartment with Break-glass facility (2 keys, 2 clear plates and 2 fasteners supplied for self-assembly) • Wooden base plate • FE and hose reel label supplied loose • Optional extras: Factory fitted alarm, 2 wooden shelves (Kit 90), Break-glass spare kit (Kit 81).





Pour stockage à l'intérieur ou en extérieur de vos bâtiments, d'extincteurs, de tuyaux d'incendie, d'appareils respiratoires, d'équipements chimiques ou absorbants • Montage mural ou pose à même le sol possibles • Joint caoutchouc et hublot en polycarbonate • Montage réversible avec ouverture de porte à droite ou à gauche • Serrures en plastique et boîte à clés avec vitre à briser (2 x clés, 2 x hublots translucides, 2 x vis plastiques, 2 x écrous plastique pour assemblage par vos soins) • Fond support en bois • Etiquettes "Extincteur" et "Tuyaux Incendie" fournies dans le coffre • En option: Alarme - montage en usine, 2 étagères en bois (Kit 90), Kit-hublots de remplacement (Kit 81).

für die Aufbewahrung von Feuerlöschern, Druckschläuchen, Atemschutzgeräten, Öl- u. Chemikalienbinder, etc. in Gebäuden sowie im Freien • für Wandmontage bzw. freistehend einsetzbar • Gummidichtung + Sichtfenster aus Polycarbonat • Montage mit Scharnieren nach rechts bzw. links • Kunststoffschlösser sowie Schlüsselkästchen mit Klarsichtscheibe (2 Schlüssel, 2 Scheiben + 2 Plastikschrauben für die Eigenmontage) • Holz-Einlegeboden • Feuerlöscher- und Löschschlauch-Aufkleber lose beigelegt • Extra: Alarm (werkseitig montiert), 2 Holzablegefächer (Kit 90), Ersatzscheiben (Kit 81).

Type		
JBDB85	●	●
JBDE85	●	●
JBDG85	●	●
JBDR85	●	●





JBDE85

					
760	850	530	565	300	375



JBKE90







Type		
JBKE90	●	●
JBKG90	●	●
JBKR90	●	●
JBKY90	●	●

					
820	900	850	930	340	420

95 Series

Série "95"





















95er-Reihe

					
915	950	360	445	195	280

Designed primarily for a 5 kg CO<sub>2</sub> extinguisher with a large nozzle • Rubber seal and polycarbonate windows • Left hinged mounting • Plastic toggles and lynch pins OR plastic locks and key compartment with Break-glass facility (2 keys, 2 clear plates and 2 fasteners supplied for self-assembly) • FE label supplied loose.

Conçu initialement pour extincteur CO<sub>2</sub> 5 kg avec large diffuseur • Joint caoutchouc et hublot en polycarbonate • Ouverture de porte à gauche seulement • Goupille de sécurité et Grenouillère plastique ou Serrures en plastique et boîte à clés avec vitre à briser (2 x clés, 2 x hublots translucides, 2 x vis plastiques, 2 x écrous plastique pour assemblage par vos soins) • Etiquette <Extincteur>.

für 5 kg Kohlendioxidlöcher geeignet • Gummidichtung + Sichtfenster aus Polycarbonat • Montage mit Scharnieren nach links • Verschlussbügel und Klappsplint aus Kunststoff oder Kunststoffschlösser sowie Schlüsselkästchen mit Klarsichtscheibe (2 Schlüssel, 2 Scheiben + 2 Plastikschrauben für die Eigenmontage) • Feuerlöscher-Piktogramm lose beigefügt.

Type			
JBWB95			
JBWE95			
JBWR95			
JBKB95			
JBKE95			
JBKR95			



JBWE95



JBKE95



**SAFETY BOXES**

**EQUIPEMENT DE SECURITE**

**SICHERHEITSKÄSTEN**

**70/72/83/85/90 Series**

Also available as Safety Boxes - see relevant description for information, noting that Safety Boxes come without any restraints/straps.

**Séries 70/72/83/85/90**













Sont aussi disponibles dans la version coffres pour équipements de sécurité. cf. descriptif pour information. Noter toutefois que ces coffres sécurité ne comprennent pas de sangle de maintien.

**70er/72er/83er/85er/90er - Reihe**

auch als Sicherheitskästen erhältlich. Wie vor jedoch ohne Haltebänder.



JBWA70

Type		
JBWA70		
JBDA72		
JBXA83		
JBDA85		
JBKA90		



JBDA72



JBDA72

**MILITARY BOXES**



**COFFRE A USAGE MILITAIRE**

**MILITÄRKÄSTEN**

NATO approved and specified for 5 years-Contract A314062/B

Référence OTAN pour 5 ans-Contrat No A314062/B.

NATO-Abnahme, Liefervertrag für 5 Jahre-Auftragsnr. A314062/B

Type		NATO. No Référence OTAN NATO-Nr.		
JBWM70KZ	KIT56	6MT1/2540-99-891-7436		
JBWE70KZ	KIT56	6MT1/2540-99-417-8725		
JBXF83	KIT56	4210-17-054-9939		



JBWM70KZ

## K Series

## Série "K"

## K-Reihe

For in-door/out-door storage of Fire extinguishers, Hose reels, Breathing apparatus, Chemicals and spillage equipment • Wall mounted or free-standing • Rubber seal and polycarbonate windows • Left or right hinged mounting • Plastic locks and key compartment with Break-glass facility (2 keys, 2 clear plates and 2 fasteners supplied for self-assembly) • Wooden base plate<sup>^</sup> • Label supplied loose • Optional extras: Factory fitted alarm (KIT ALARM), Break-glass spare kit (Kit 81).

Pour stockage à l'intérieur ou en extérieur de vos bâtiments, d'extincteurs, de tuyaux d'incendie, d'appareils respiratoires, d'équipements chimiques ou absorbants • Montage mural ou pose à même le sol possibles • Joint caoutchouc et hublot en polycarbonate • Montage réversible avec ouverture de porte à droite ou à gauche • Serrures en plastique et boîte à clés avec vitre à briser (2 x clés, 2 x hublots translucides, 2 x vis plastiques, 2 x écrous plastique pour assemblage par vos soins) • Fond support en bois<sup>^</sup> • Etiquettes fournies dans le coffre • En option: Alarme - montage en usine (KIT ALARM), Kit-hublots de remplacement (Kit 81).

für die Aufbewahrung von Feuerlöschern, Druckschläuchen, Atemschutzgeräten, Öl- u. Chemikalienbinder, etc. in Gebäuden sowie im Freien • für Wandmontage bzw. freistehend einsetzbar • Gummidichtung + Sichtfenster aus Polycarbonat • Montage mit Scharnieren nach rechts bzw. links • Kunststoffschlösser sowie Schlüsselkästchen mit Klarsichtscheibe (2 Schlüssel, 2 Scheiben + 2 Plastikschrauben für die Eigenmontage) • Holz-Einlegeboden<sup>^</sup> • Piktogramme lose beigefügt • Extra: Alarm werkseitig montiert (KIT ALARM), Ersatzscheiben (Kit 81).

<sup>^</sup> JBKE90 only / JBKE90 uniquement / nur JBKE90

Type	mm	mm	mm	mm	mm	mm
JBKE70	620	700	260	300	210	253
JBKE72	640	720	525	565	220	270
JBKE83	750	830	270	310	220	263
JBKE85	760	850	500	565	300	375
JBKE90	820	900	850	930	340	420
JBKE95	915	950	360	425	195	280



JBKA85



JBKE72



JBKA70

The standard colour scheme for the 'K' Series is a red door with a black body. However, other colour schemes are available and are denoted by the third and fourth digit of the product coding.

Le coffre standard de la série "K" se compose d'une porte rouge et d'un coffret noir. D'autres associations de coloris sont disponibles et vous les repérez dans la référence du produit sur les 3 et 4èmes caractères composant le code article.

Standardfarbe der K-Reihe: roter Deckel/schwarzer Kasten. Nachfolgende Farbkombinationen sind auf Anfrage erhältlich und werden durch die dritte und vierte Ziffer der Typenkenntung festgelegt.

Type	Red Door	Black Door	Icons
KE	Red	Black	Fire extinguisher, Hose reel, * (alarm)
KB	Black	Black	Fire extinguisher, Hose reel, * (alarm)
KR	Red	Red	Fire extinguisher, Hose reel, * (alarm)
KA	Green	Black	Fire extinguisher, Hose reel, Spill kit, + (alarm)
KY	Yellow	Black	Fire extinguisher, Hose reel, Spill kit, + (alarm)

\*90 Series only / la série "90" uniquement / nur 90er-Reihe

**K Series****Série "K"****K-Reihe****Emergency key facility fitment**

The key for the cabinet is located behind a clear plate, that is held in place with two plastic fasteners. In an emergency the clear plate can be broken away, providing access to the key for the cabinet. A new clear plate can be re-attached using the same plastic fasteners.

**Montage du hublot donnant accès à la clé en cas d'urgence**

La clé de ce coffret se trouve derrière un hublot translucide maintenu par 2 vis plastique. En cas d'urgence, il suffit de briser ce hublot pour accéder à la clé. Un nouveau hublot peut être fixé à l'aide de vis plastique.

**Notschlüssel-Montage**

Der Schlüssel befindet sich hinter einer Klarsichtscheibe, die mit 2 Plastikschrauben gesichert ist. Im Notfall wird die Scheibe zerbrochen, damit der Schlüssel entnommen werden kann. Eine Ersatzscheibe kann mit den beigegefügten Schrauben montiert werden.

**Factory fitted alarm**

A reed switch activated 120 dB self contained 9 V alarm with three minute automatic reset upon activation. Alarm does not interfere with use of equipment. Coding example: JBKE70A.

**Alarme - Montage en usine**

En option montage d'une alarme auto-alimentée de 9v dégageant une puissance sonore de 120 décibels et se réactivant automatiquement toutes les 3 minutes. L'alarme n'empêche pas d'utiliser le coffre. Par exemple JBKE70A.

**Alarm (werkseitig montiert)**

Unabhängige, störungsfreie Einheit mit Reedschalter und 9 V Batterie. Automatische Rückstellung drei Minuten nach der Aktivierung. Schallstärke: 120 dB. Typenkennung: z. B. JBKE70A.



JBKE70

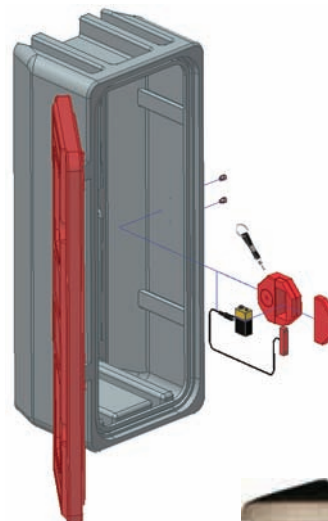
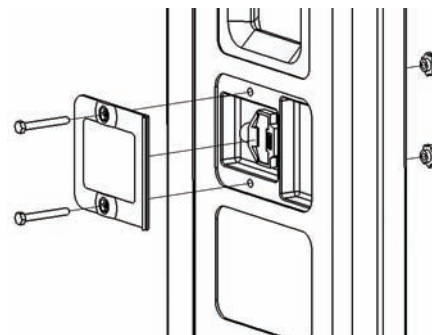

## 64 Series

## Série "64"

## 64er-Reihe

For extinguishers up to 170 mm dia • Truck & trailer mounting • Internal strap to secure cylinder • Moulded-in fixing points for ease of fitment • Double-skinned lid with waterproof seal • Plastic toggle, lynch pin and hinge pins as standard • Textured surface finish • Optional extra: Kit 65 for vehicle mounting (30° or 60°).

Pour extincteur de diamètre inférieur à 170 mm • Montage possible sur camion et remorque • Ressort de blocage de l'extincteur dans la boîte • Points de fixations moulés facilitant le montage • Couvercle double paroi avec joint étanche • Goupille de sécurité, charnières et fermetures en plastique avec chaque coffre • Etat de surface grené • Option: Kit 65 permettant la fixation à 30° ou 60°.

für Löscher bis 170 mm ø • LKW- oder Hängermontage • Innen-Federband zur Fixierung des Löschers • eingesinterte Montagehilfen für problemlosen Anbau • doppelwandiger Deckel mit Neoprendichtung • Verschlussbügel, Klappsplint und Scharniere aus Kunststoff • strukturierte Oberfläche • Extra: Kit 65 für Montagewinkel 30° oder 60°.

## 65 Series

## Série "65"

## 65er-Reihe

Strong durable design & lightweight • Truck & trailer mounting • Internal tension strap helps prevent movement by the cylinder • Plastic toggle, lynch pin and hinge pins as standard • Flat back for ease of mounting • Optional extras: Company logo, colours.

Chargement par le dessus • Structure renforcée et légère • Montage possible sur camion et remorque • Ressort de blocage de l'extincteur dans la boîte • Goupille de sécurité, charnières et fermetures en plastique avec chaque coffre • Surface de fixation plane pour faciliter le montage • En option: Marquage à votre logo, coloris.





leichte, robuste Ausführung • für LKW- oder Hängermontage • Innen-Federband zur Fixierung des Löschers • Verschlussbügel, Klappsplint und Scharniere aus Kunststoff • Montageerleichterung durch flache Rückseite • Extras: Kundenlogo, Sonderfarben.

Type	
JBFB64	
JBFR64	

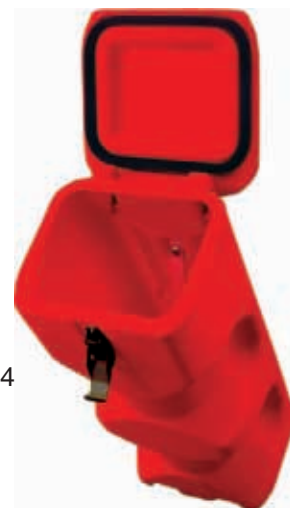



JBFR64



 mm	 mm	 mm	 mm	 max mm
640	250	250	590 max	170 max



JBFR65

Type	
JBFB65	
JBFR65	



 mm	 mm	 mm	 mm	 max mm
650	260	275	600 max	180 max

**75 Series**



**Série "75"**





**75er-Reihe**

As 65 Series.

Comme la Série "65".

Wie 65er-Reihe.

Type	
JBFB75	
JBFR75	

 mm	 mm	 mm	 mm	 max mm
750	300	300	600+	230 max



JBFR75

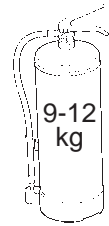

**SAFETY BOXES**

**EQUIPEMENT DE SECURITE**

**SICHERHEITSKÄSTEN**

**64/65/75 Series**

Also available as Safety Boxes - see relevant description for information, noting that Safety Boxes come without any restraints/straps.

**Séries 64/65/75**

Sont aussi disponibles en version coffres pour équipements de sécurité. cf. descriptif pour information, noter toutefois que ces coffres sécurité ne comprennent pas de sangle de maintien.

**64er/65er/75er-Reihe**

auch als Sicherheitskästen erhältlich. Wie vor jedoch ohne Haltebänder.

Type	
JBFA64	
JBFA65	
JBFA75	



JBFA65 & JBFA75

**MILITARY BOXES**

**COFFRE A USAGE MILITAIRE**

**MILITÄRKÄSTEN**





NATO approved and specified for 5 years-Contract A314062/B • Boxes available in NATO green • Independently drop and vibration tested (-35°C) • Strong and durable enough for military use.

Référence OTAN pour 5 ans-Contrat No A314062/B. • Coffres disponibles dans colori vert OTAN • Tests d'impact et de vibration (-35°C) • Grande longévité et résistant même pour un usage militaire.

NATO-Abnahme, Liefervertrag für 5 Jahre-Auftragsnr. A314062/B • erhältlich in NATO-Oliv • unabhängiger Aufprall- und Vibrationstest (-35°C) • robust und stoßfest, ideal für den Militäreinsatz.



JBFM65K

Type		NATO. No Référence OTAN NATO-Nr.	
JBFM65K	KIT55	6MT1/2540-99-0751-9118	
JBFR65K	KIT55	6MT1/2540-99-987-5386	



**DIMENSIONS**  
64 Series

**MAÛE**  
Série "64"

64er-Reihe

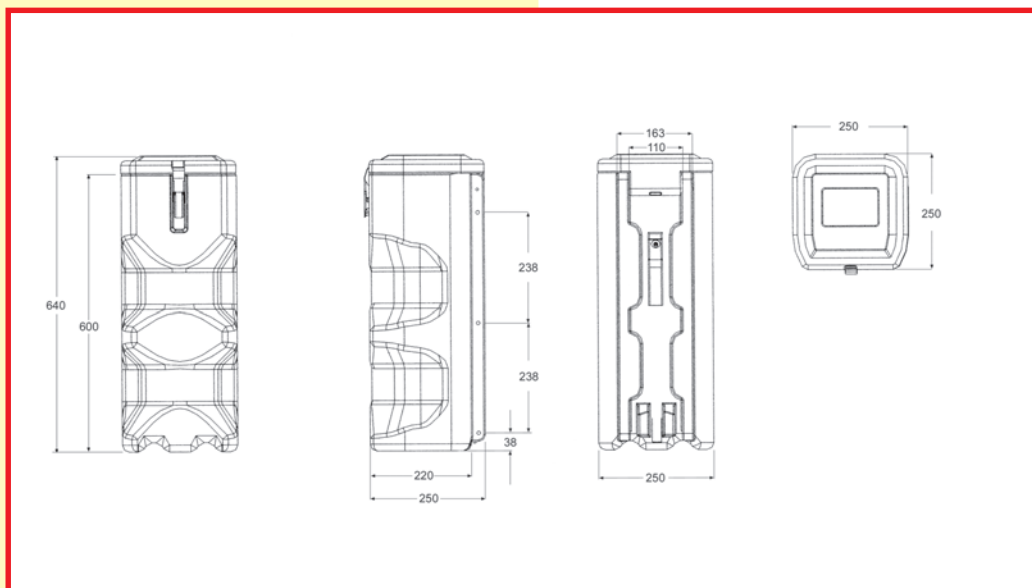

**NOTE**

**ATTENTION**

**ACHTUNG**

When fitting horizontally the boxes should be mounted so that the extinguisher does not rest on top of the tension strap.

En cas de montage horizontal, les coffres doivent être montés de tel façon que l'extincteur ne repose pas sur le ressort de blocage.

Bei waagerechtem Anbau die Kästen so montieren, daß der Feuerlöscher nicht auf dem Federband aufliegt.

Placement of the fire extinguisher label.  
Positionnement de l'étiquette <Extincteur>  
Feuerlöscher-Piktogramm

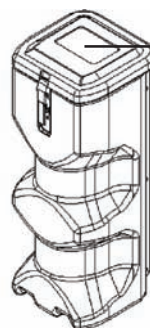

Fit fire extinguisher label here.  
Mettez l'étiquette ici.  
Aufkleber hier anbringen.

**DIMENSIONS**  
65-75 Series

**MAÛE**  
Série "65-75"

65/75er-Reihe

Type	A mm	B mm	C mm	D mm	E mm	F mm	G mm
JBFR65	240	240	650	70	500	85	45
JBFR75	300	270	750	115	500	130	100

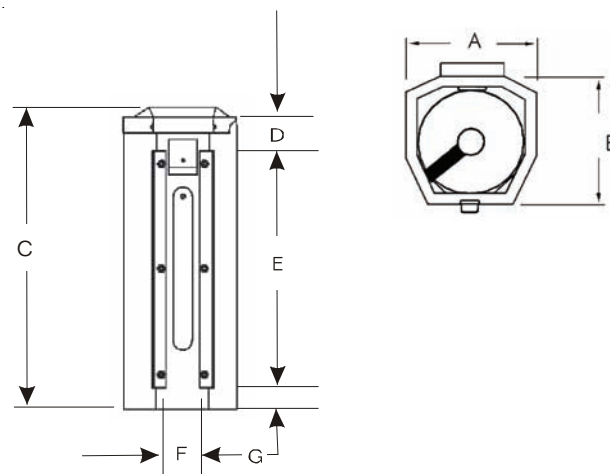

**JBX Series**

**Série "JBX"**

**JBX-Reihe**

Ideal for in-door/out-door storage of Fire extinguishers, Breathing apparatus equipment, Firehose reels, Fire blankets, sand, First aid equipment • Splash proof • Lockable • Chemical resistant • Fully recyclable PE • Standard colour: red • Optional extra: Company logo, colour.

Ideal pour le stockage extérieur ou intérieur de l'extincteur, d'appareil respiratoire, de tuyaux d'incendie, de couverture de survie, de sable, de trousse de 1<sup>er</sup> secours • étanche • cadenassable • résistant aux produits chimiques • fabriqué dans un polyéthylène entièrement recyclable • Colori standard: rouge • En option: Marquage à votre logo et gamme de couleurs possible.

Ideal für die Aufbewahrung von Feuerlöschern, Atemschutzgeräten, Druckschläuchen, Löschdecken, Sand, Erste-Hilfe-Ausrüstungen, etc. in Gebäuden sowie im Freien • spritzwassergeschützt • abschließbar • chemikalienbeständig • vollständig recycelbares PE • Standardfarbe: rot • Extras: Kundenlogo, Sonderfarben.

Type	mm	mm	mm	kg	l
JBX65-COR	500	650	480	8	110
JBX80-COR	500	800	480	10	140
JBX100-COR	500	1000	480	12	170
JBX120-COR	500	1200	480	15	210

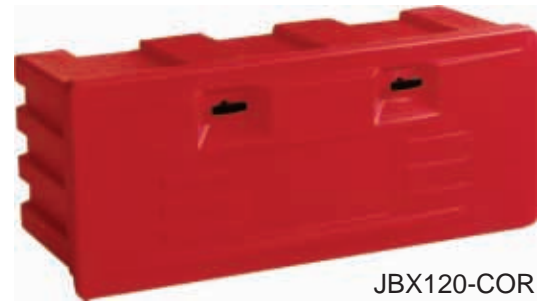

JBX120-COR



JBX80-COR



**GRIT BOXES**

**COFFRE POUR GRIT**

**STREUGUT-KÄSTEN**

**JBS Series**

**Série "JBS"**

**JBS-Reihe**

For in-door/out-door storage of grit, sand, salt, Chemicals and spillage equipment • Optional extras: Logo service available, Plastic toggle (coding example: JBS65P).

Pour stockage à l'intérieur ou en extérieur de grit, sable, sel, d'équipements chimiques ou absorbants • En option: Logo personnalisé sur demande, Grenouillère plastique (par exemple: JBS65P).

für die Aufbewahrung von Streugut, Salz, Sand, Öl- u. Chemikalienbinder, etc. in Gebäuden sowie im Freien • Extra: Kundenlogo auf Wunsch, Verschlussbügel aus Kunststoff (Typenkennung: z.B. JBS65P).

Type	mm	mm	mm	kg	l
JBS65-CORE				●	
JBS65-COGR	570	650	500	●	8
JBS65-COYE				●	110



JBS65-COYE



JBS65-COGR



JBS65P-CORE



WIN- A607

Plastic Shovel  
Pelle en plastique  
Kunststoffschaufel

STANDS WITHOUT BACK

SOCLES SANS DOSSERET

STÄNDER OHNE RÜCKEN

Available as single/double stands • Suitable for all portable extinguishers • No corroding parts • Ideal for public buildings, offices, hotels, exhibitions, etc. • Non-slip design • Recessed top to accommodate extinguisher • Immediate access in case of emergency • Fire extinguisher label • Optional extras: Colour.

Pour 1 ou 2 extincteurs • Convient à tout type d'extincteur portable • Structure renforcée malgré sa légèreté • Résiste à la plupart des agents chimiques • Insensible à la corrosion • Fabriqué dans un polyéthylène recyclable respectueux de l'environnement • Idéal pour tout lieu public - bureaux, hôtels, parc des expositions etc. • Embase anti-dérapante • Logement adapté à tout type d'extincteur • Accès immédiat en cas d'urgence • Etiquette <Extincteur> • En option: Coloris.

als Einzel-/Doppelständer erhältlich • für alle tragbaren Feuerlöscher • leichte, robuste Ausführung • chemikalienbeständig • rostfrei • aus umweltfreundlichem PE - 100%ig recycelbar • ideal für öffentliche Gebäude, Büros, Hotels, Ausstellungen, etc • rutschsicher • vertiefte Löscher-Standfläche • im Ernstfall sofort griffbereit • Feuerlöscher-Piktogramm • Extras: Sonderfarben.

JFP5

CO<sub>2</sub> extinguisher stand. Also suitable for use with JFP3/4/6. Support pour extincteur CO<sub>2</sub>. Peut s'utiliser également avec les réf. JFP3/4/6.

Ständer für CO<sub>2</sub>-Feuerlöscher; auch für JFP3/4/6 geeignet.



JFP1-BIGE



JFP1



JFP2-MG10



JFP2

JFP5-MG10



Type	mm	mm	mm	Ø max mm	kg	
JFP1						
JFP1-BIGE	200	345	345	205	1.5	
JFP1-MG10						
JFP2						
JFP2-BIGE	150	645	320	205	3.0	
JFP2-MG10						
JFP5						
JFP5-BIGE	240	220	207	110-120	1.0	
JFP5-MG10						



JFP5



**STANDS WITH BACK**

Available as single/double stands • Suitable for all portable extinguishers • Ideal for public buildings, offices, hotels, exhibitions, etc. • Non-slip design • Recessed top to accommodate extinguisher • Immediate access in case of emergency • Fire extinguisher label • Optional extras: Colour.

Pour 1 ou 2 extincteurs • Convient à tout type d'extincteur portable • Idéal pour tout lieu public - bureaux, hôtels, parc des expositions etc. • Embase anti-dérapante • Logement adapté à tout type d'extincteur • Accès immédiat en cas d'urgence • Etiquette <Extincteur> • En option: Coloris.

als Einzel-/Doppelständer erhältlich • für alle tragbaren Feuerlöscher • ideal für öffentliche Gebäude, Büros, Hotels, Ausstellungen, etc. • rutschsicher • vertiefte Löscher-Standfläche • im Ernstfall sofort griffbereit • Feuerlöscher-Piktogramm • Extras: Sonderfarben.

JFP4-BIGE & JFP5-BIGE



**JFP6**

Triple stand  
Socle pour 3 Extincteur  
Dreifachständer

JFP3/JFP4 combination stand • Supplied as two separate units in one box for self assembly • Assembly kit included.

Socle combiné pour JFP3/JFP4 • Fourni en 2 unités séparées dans le même carton pour assemblage selon votre convenance • Kit d'assemblage inclus.

JFP3/JFP4-Kombiständer • lose verpackt im Karton für Eigenmontage • Montagesatz beigelegt.



JFP5 & JFP6

**SOCLES AVEC DOSSERET**

**STÄNDER MIT RÜCKEN**

JFP3-MG10

JFP3

JFP3-BIGE



JFP4



JFP4-MG10



JFP6

STANDS WITH BACK

SOCLES AVEC DOSSERET

STÄNDER MIT RÜCKEN

**JFP7**

Suitable for one 6 litre foam fire extinguisher and one 2 kg CO<sub>2</sub> fire extinguisher • Fire extinguisher label • Anti-slip Pads • Optional extras: Colour, CO<sub>2</sub>/Foam Labels (KIT-LAB-FOAM-CO2).

Convient pour un extincteur 6 kg à eau et un extincteur 2 kg CO<sub>2</sub> • Etiquette extincteur • embase antidérapante • Options : Etiquette extincteur CO<sub>2</sub> et extincteur à eau (KIT-LAB-FOAM-CO2).

für je einen 6 l Schaumlöschler und einen 2 kg Kohlendioxidlöschler • Feuerlöscher-Piktogramm • rutschfeste Füße • Extras: Sonderfarben, CO<sub>2</sub>-/Schaumlöschler-Piktogramm (KIT-LAB-FOAM-CO2).



JFP7



JFP7



JFP7-BIGE



JFP7-MG10

Type	mm	mm	mm	∅ max mm	kg	
JFP3						
JFP3-BIGE	750	320	300	240	2.6	
JFP3-MG10						
JFP4						
JFP4-BIGE	750	620	300	240	5.2	
JFP4-MG10						
JFP6						
JFP6-BIGE	750	940	300	240	8.2	
JFP6-MG10						
JFP7						
JFP7-BIGE	620	480	270	195/125	3.6	
JFP7-MG10						

JFPINSERT

Fire stand insert for smaller diameter extinguishers • Suitable for use with JFP1/JFP2/JFP7 • Ideal for extinguisher with  $\varnothing \leq 165$  mm • Optional extras: Colour.

Support pour extincteur de petit diamètre • Peut s'utiliser avec les réf. JFP1/JFP2/JFP7 • Idéal pour extincteur  $\varnothing \leq 165$  mm • En option: coloris.

Einsatz für Feuerlöscher mit kleinem Durchmesser • geeignet für Feuerlöscher JFP1/JFP2/JFP7 • ideal für Feuerlöscher  $\varnothing \leq 165$  mm • Extras: Sonderfarben.



JFPINSERT



JFP1 & JFPINSERT

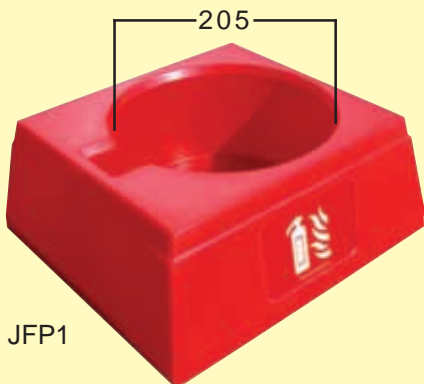

JFP1

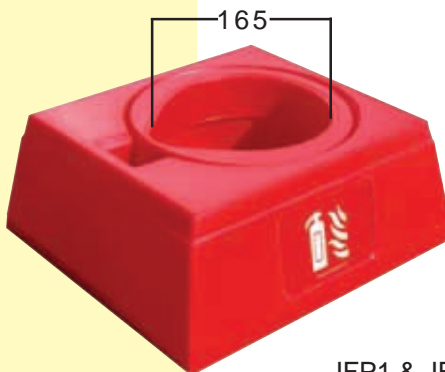







JFP2



JFP2 & JFPINSERT



JFP7 & JFPINSERT

Type	mm	 $\varnothing$ mm	 $\varnothing$ max mm	kg	
JFPINSERT					
JFPINSERT-BIGE	105	225	160	0.5	
JFPINSERT-MG10					

**KITS MONTAGESÄTZE****KIT 50**

Rubber Strap  
Sangle de maintien caoutchouc  
Gummi-Innenhaltebänder

**KIT 51**

Buckle Web Strap / Sangle Renforcée / Gurtband mit Schnalle

**KIT 55****65-75 Series / Série 65-75 / 65/75er-Reihe**

Kit for mounting Top Loaders to a vehicle at an angle (30° or 60°).

Kit de montage pour coffre porte extincteur à chargement par le dessus sur un véhicule selon un angle (30° ou 60°).

Montagesatz für Toplader (Montagewinkel 30° oder 60°).

**KIT 56****65-75 Series / Série 65-75 / 65/75er-Reihe**

Basic kit for mounting; also suitable for front loaders.

Kit standard pour le montage.

Montage-Grundversion; kann auch für Frontlader eingesetzt werden.

**KIT 65****64 Series / Série 64 / 64er-Reihe**

Kit for mounting Top Loaders to a vehicle at an angle (30° or 60°).

Kit de montage pour coffre porte extincteur à chargement par le dessus sur un véhicule selon un angle (30° ou 60°).

Montagesatz für Toplader (Montagewinkel 30° oder 60°).

**KIT 80****70-83 Series / Série 70-83 / 70/83er-Reihe**

Kit for mounting Front Loaders to a landing leg.

Kit de montage pour coffre porte extincteur à chargement frontal sur une béquille.

Montagesatz für die Befestigung von Frontladern an Stützvorrichtungen.



KIT 50



KIT 51

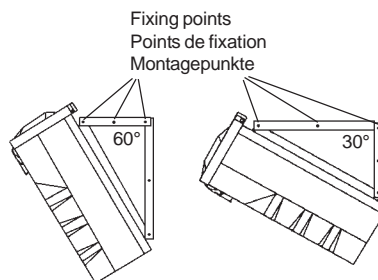

Fixing points  
Points de fixation  
Montagepunkte



KIT 55

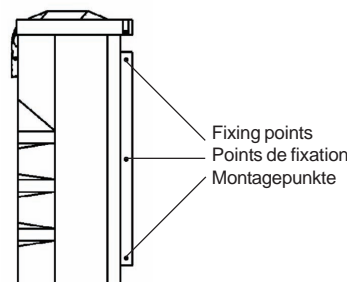

Fixing points  
Points de fixation  
Montagepunkte



KIT 56

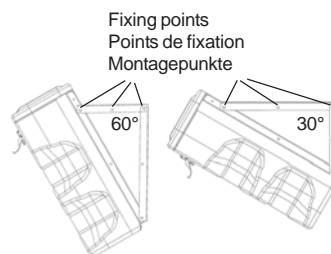

Fixing points  
Points de fixation  
Montagepunkte



KIT 65

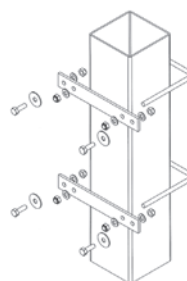

KIT 80



**KITS MONTAGESÄTZE**

**KIT 52**

Free Standing Feet  
 Pied support pour utilisation du coffre seul  
 Füße für freistehenden Einsatz

**KIT SHELF72**

2 plastic shelves for 72 Series  
 2 étagères en plastique pour coffres de la série "72"

2 Kunststoffablegeflächen für 72er-Reihe

**KIT SHELF85**

2 plastic shelves for 85 Series  
 2 étagères en plastique pour coffres de la série "85"

2 Kunststoffablegeflächen für 85er-Reihe

**KIT 90**

2 wooden shelves for 90 series  
 2 étagères en bois pour coffres de la série "90"

2 Holzablegeflächen für 90er-Reihe

**KIT 57**

2 wooden shelves for 85 series  
 2 étagères en bois pour coffres de la série "85"

2 Holzablegeflächen für 85er-Reihe

**KIT ALARM**

Alarm Kit  
 Kit - Alarme  
 Alarmeinheit

**KIT 81**

Spare Break-Glass  
 Kit-hublots de remplacement  
 Ersatzscheiben

**KIT 91**

Spare Keys (10 pieces)  
 Clés de remplacement (10 pièces)  
 Ersatzschlüssel (10 Stck.)

**LABELS ETIQUETTES PIKTOGRAMME**

10 labels per Kit in a plastic bag.  
 10 étiquettes par kit et par sachet.  
 10 Piktogramme/Kit im Folienbeutel.



Fire Extinguisher/Incendie/Feuerlöscher  
**KIT-LAB-FIRE**



Fire Extinguisher - German  
 Incendie - Allemagne  
 Feuerlöscher - Deutsch  
**KIT-LAB-FIREGERMAN**



Fire Extinguisher - Swedish/Incendie - Suède/  
 Feuerlöscher - Schwedisch  
**KIT-LAB-FIRESWEDEN**



Fire Hose Reel/Tuyaux d'incendie/  
 Löschschlauch  
**KIT-LAB-HOSEREEL**

KIT SHELF72



KIT 52

KIT SHELF85

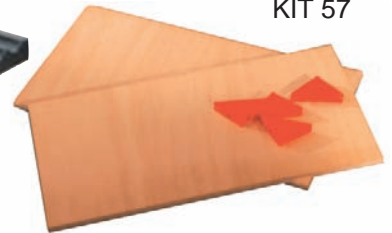
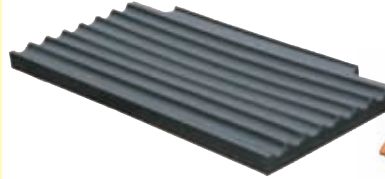

KIT 57

KIT 90



KIT ALARM



KIT 81



KIT 91



Breathing Apparatus/Appareils Respiratoires/  
 Atemschutzgeräte  
**KIT-LAB-BA**



First Aid/1<sup>er</sup> secours/Erste Hilfe  
**KIT-LAB-FIRSTAID**



**KIT-LAB-SPILLKIT**



**KIT-LAB-ADR**



**KIT-LAB-FOAM-CO2**

1 Kit = 1 x CO<sub>2</sub> Label and 1 x Foam Label  
 1 Kit = 1 x étiquette extincteur CO<sub>2</sub> et 1 x étiquette extincteur à eau  
 1 Kit = je ein Kohlendioxidlöschers- und ein Schaumlöschers-Piktogramm









**JONESCO 2009 FIRE AND SAFETY CATALOGUE**

All rights reserved. No part of this publication may be reproduced, stored in a retrieval system or transmitted in any other form or by any means electronic, mechanical, photographic, recording or otherwise without the prior written permission of the publisher Jonesco (Preston) Ltd. We reserve the right to modify the specifications and ranges of the products illustrated in this catalogue without prior notice. All dimensions are nominal. All deliveries according to our Conditions of Sale and Delivery. Jonesco (Preston) Ltd. Preston.

**CATALOGUE PRODUITS INCENDIE ET SECURITE JONESCO 2009**

Ce catalogue est notre propriété intellectuelle! Il est interdit de le communiquer à un Tiers. Contrefaçon (partielle), ainsi que l'utilisation de nos illustrations et du contenu n'est possible qu'avec notre accord écrit. Jonesco se réserve le droit de modifier la gamme des produits présentés au catalogue sans préavis. Toutes les dimensions sont nominales. Les livraisons découlent de nos conditions de livraison et de paiement. Jonesco (Preston) Ltd. Preston.

**JONESCO-BRANDSCHUTZKATALOG 2009**

Dieser Katalog ist unser geistiges Eigentum! Weitergabe an Dritte ist untersagt. Nachdruck - auch auszugsweise - sowie Verwendung des Inhalts in jedweder Form (elektronisch, mechanisch, photographisch, etc.) ist nur mit unserer ausdrücklichen schriftlichen Genehmigung möglich. Wir behalten uns das Recht vor, Maße und Ausführungen der hier abgebildeten Produkte ohne Vorankündigung zu ändern. Alle Maße sind Nennwerte. Lieferungen erfolgen zu unseren Lieferungs- und Zahlungsbedingungen. Jonesco (Preston) Ltd. Preston.



**ISO 9001:2000**

**v14**



**Fire & Safety Products  
Produits Incendie et Sécurité  
Brandschutz- & Sicherheitsprodukte**

**+44 (0) 1772 706888**

**Contact Name    Nom et Contact    Ansprechpartner**

--

